

OWNER'S MANUAL

- Application
- Notable Features
- Specifications
- Installation
- Operation
- Maintenance
- Warranty

Eagle 2500TM

Electronic Air Purification 110 and 220 volt Systems

EcoQuest International[®]

310 T. Elmer Cox Drive • Greeneville, TN 37743 • 423.638.7246

www.ecoquest.com

CAUTION: read manual carefully for proper procedures and operation.

CONTENTS

Applications 3

Notable Features 3

Model Specifications 3

Principles of Operation 4

Pre-Installation / Inspection 4

Ozone Plate/Lint Screen Install 5

Placing the Unit 6

Setting / Adjusting Controls 7

Maintenance 8

Troubleshooting..... 9-11

Warranty 12

Please record the serial number of your Eagle 2500:

Serial # _____

Please record the name and phone of your EcoQuest Dealer:

Name _____

Phone _____



**CAUTION! - Disconnect power cord before servicing.
Use 1.0 AMP slow blow fuse.**

CAUTION: Do not operate unit without one or all ozone plate(s) properly installed. Doing so may void your warranty.

Applications

Eliminate

- Smoke
- Odors
- Tobacco Smoke

Plus it works as an appliance to Sanitize an area to Reduce

- Mold
- Mildew
- Bacteria

For use in your Salon, Home, Apartment, Office, Automobile, Boat... anywhere you need clean air!

Notable Features

- Compact
- Portable
- No Duct Work Required
- No Chemicals
- Low Maintenance
- Low Electrical Use
- Complete User Control
- No Residual Contamination
- Plugs into 110 (or 220) volt outlet

Specifications

- Positive/Negative Ion Generation Technology
- Ozone Generation

Features:

- Adjustable fan speed control
- Washable permanent lint screen
- Adjustable ozone control

Electrical:

- 120 volt 60 Hz or 220v 50 Hz
- 60 watts power consumption
- 24 to 30 KV, 20-30 khz ion generation pulsator
- 20 KV negative ion generator

Mechanical:

- 350 CFM fan

Size:

- Height: 13 3/4"; Width: 8"; Depth: 9 3/4"
- Weight: 20 pounds

Ozone Output:

- 0-390 mg per hour (dependent on the number of plates installed.)

Warranty:

- 3 years parts and labor (excludes plates) on 110 volt models
- 1 year parts on 220 volt models

PRINCIPLES OF OPERATION

Nature cleanses the air with the lightning and rain. Lightning bolts produce ozone, as well as positive and negative ions which cleanse the air naturally. Rain helps bring the ozone and ions closer to the earth's surface. They are then attracted to atmospheric contaminants that are either removed from the air and attached to grounded objects or are oxidized.

The Eagle 2500 reproduces the natural conditions found in the outdoors. It is not designed to create an artificial environment. The re-establishment of a natural environment takes place out in the air, rather than inside the unit. It cleanses the air, rather than filtering it, masking the symptoms, or attempting to dilute it.

PRE-INSTALLATION AND INSPECTION

1. Remove unit from shipping carton
2. Remove all protective materials
3. Check for shipping damage and loose or broken parts
4. Read Owners Manual thoroughly prior to installation
5. Remove glass plates from the box and install
6. OPTIONAL: Plug the unit into a 110 volt (or 220 volt) outlet, place in shipping box with unit on and purifier knob set to maximum for at least one hour to remove traces of manufacturing odor.
7. Determine placement location for the unit, plug the unit into 110 volt (or 220 volt) outlet and adjust controls according to the application.

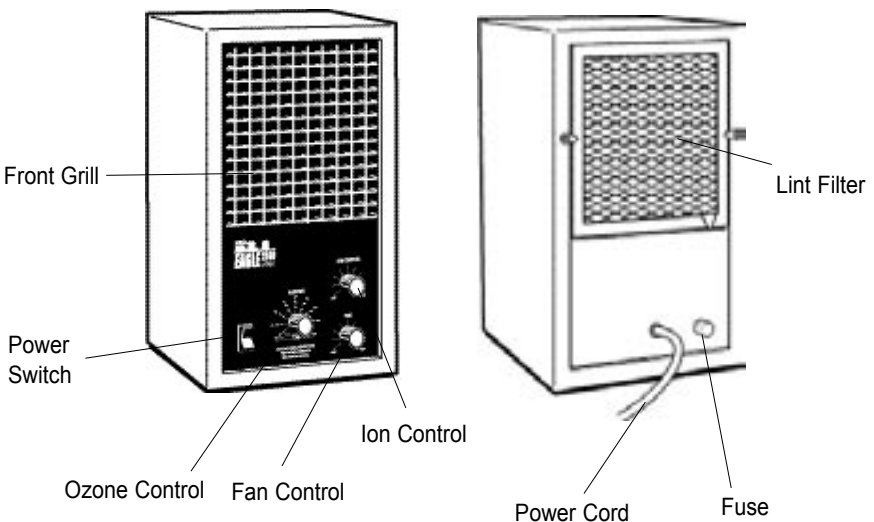

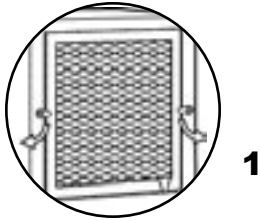

1

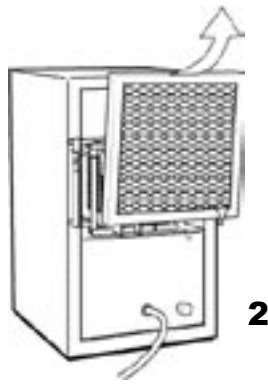

2

OZONE PLATE INSTALLATION

The Eagle 2500 utilizes three glass ozone plates.

1. Rotate the lint screen retainers out of the way.
2. Remove the rear lint screen.
3. After determining the square footage, use the purifier chart to determine the correct number of plates to install.

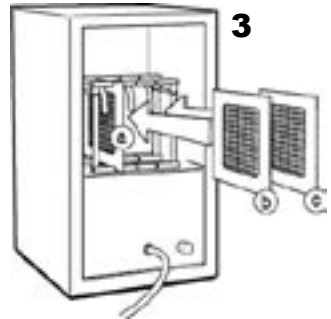

3

4. Fully insert the needed ozone plates (a,b,c) between the guide-grooves in the top and bottom of the plate cage (between the posts and clips) making sure the metal clip on each side of the plate is in contact with the metal screen on the plate.
5. Re-install lint screen as shown below.

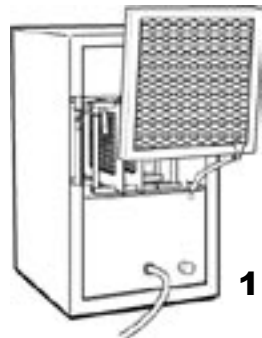

1

LINT SCREEN INSTALLATION

1. Always install bottom of lint screen first.
2. The white lint screen tab should depress the safety switch arm towards the front of unit.
3. Fit top of lint screen into cabinet.

Unit will not operate if safety switch is not depressed.

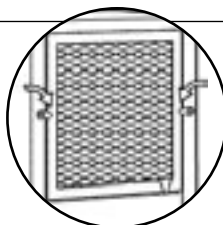

4

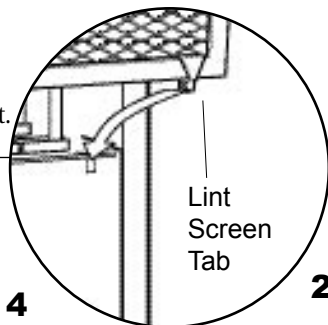

2,3

4. Secure with lint screen retainers.

PLACING THE UNIT

Place the unit as high as possible to insure complete purification.

If raised placement is not available, place unit as high as possible and elevate front of unit so fan blows towards ceiling.

Some pollutants, such as smoke, rise and the unit, when elevated, can oxidize the pollutants more effectively. A ceiling fan can also aid in distribution of cleansing properties.

The Eagle 2500 is most effective when placed in a position that allows the ions and ozone to be mixed evenly and thoroughly with the polluted air.



Suggested locations, listed in the order of preference:

1. Nearest the source of the worst pollution.
2. Near a cold-air return to thoroughly circulate clean air throughout the area.
3. In the area most heavily used to achieve maximum benefit.

Note:

- For maximum control the unit should be placed where easy access to the controls is possible.
- The rear of the unit should always have at least one inch of open area to allow unrestricted airflow.
- Be sure power cord is not accessible to small children to prevent injury.

Caution: *This unit should never be placed where it can blow directly into the face of any person or pet.*

SETTING AND ADJUSTING CONTROLS

1. FAN CONTROL

The disbursement of cleansing properties is best accomplished with good air circulation. The fan control should be set as high as reasonably possible without creating an undesirable noise level. This will be determined by personal preference and the distance you wish the cleansing properties to be dispersed.

Note: A ceiling fan can also aid in distribution of cleansing properties.

2. OZONE CONTROL

Ozone Control: Set the control at the nine o'clock position for one hour.

Adjust the ozone control up or down after one hour based on the following criteria:

1. In normal conditions it is not necessary to turn the ozone control indicator above the square-footage of the environment. (*refer to purifier chart, pg.5*)
2. Keeping in mind the previous statement (#1), adjust the purifier so that the odor of ozone fades into the background 15-30 seconds after entering the environment.

3. SANITIZING AN AREA

To sanitize an approximately 12x12 area for mold, mildew, or bacteria, turn the unit on high for 3-4 hours.

Caution: Always be sure a room or area is UNOCCUPIED before performing the above described sanitizing procedure.

Air out room by opening door and/or window.

4. ION CONTROL

The normal setting of a DC ionizer is full negative. This setting seems to work best in removing particulate (cigarette smoke) as well as reducing static. When trying to reduce static, if the full negative setting results in more static, turn the ion control in small increments towards the positive until the static is relieved.

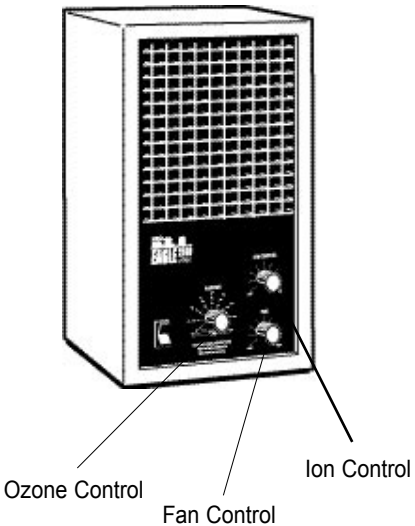

MAINTENANCE

Periodic maintenance is required to insure that the Eagle 2500 operates properly. A severely polluted environment can foul an ozone plate in as little as two weeks or as long as a year. Shown here are basic maintenance procedures that should be carried out to keep your unit running at top performance.

Rear lint-screen filter cleaning:

You have two options to clean the lint screen:

- When visibly dirty, simply remove the lint screen and with a hand-held vacuum remove the heavy particulate from the screen. This method will extend the life of the filter.

- OR -

- When visibly dirty, remove the lint screen from the back of the unit and wash in hot water, brushing gently with a toothbrush to remove particulate. Allow to dry prior to re-installing the lint screen.

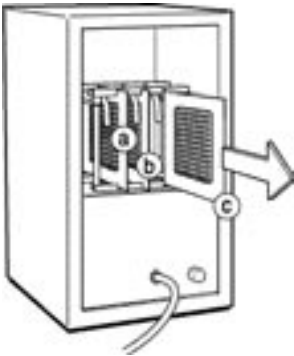

Ozone Plate

Carefully remove the glass ozone plates (a, b & c) from the card cage by grasping the middle of the edge nearest to you, and slowly pulling straight out.

Clean the ozone plate with hot water and ammonia. Dry completely using a hair

dryer if necessary. Reinstall ozone plates. Be sure to check that the electrical tabs are in contact with the plate.

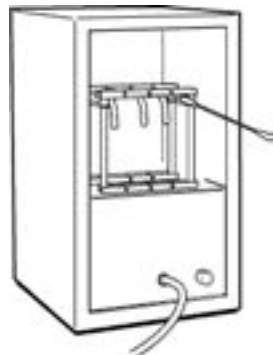

Plate Card Cage

Also be sure to clean the stand-offs at the corners of the ozone plate card cage. (A cotton swab with alcohol works well.)

Fan Blade and Front Grill

Wipe off fan blade and front grill if dirty with damp washcloth. The fan requires no maintenance (with the exception of the first time it is used, when it may be necessary to give it a gentle push to get it started). If the fan squeaks, a drop of lightweight oil may be needed on the fan shaft.



REPLACING THE FUSE

A fuse holder is located on the back of the unit next to the power cord. To replace or check the fuse, unscrew the fuse holder cap by turning it counterclockwise then remove the cap and fuse.

If the fuse is blown, replace with a new 1.0 amp slow blow type fuse. Insert the new fuse into the fuse holder and replace the fuse holder cap.

If the fuse holder cap is not installed correctly, the unit will not operate.

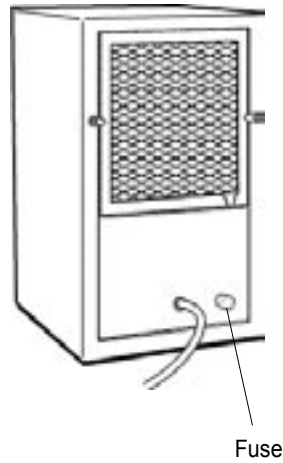

TROUBLESHOOTING

Indicators of Operation

Operation of the ion indicator lamp:

Turn the unit on and check that the small red/orange lamp is illuminated. The lamp is located inside the unit and is viewed by looking into the unit through the front grill. Illumination of the internal lamp verifies that the frequency type ionizer is functioning properly. The lamp should stay illuminated as long as the unit is turned on.

Troubleshooting - What to look for first.

1. I have plugged in the unit, turned "ON" the power switch and nothing happens...what's wrong?

- Make sure the electrical outlet is capable of providing power to the unit.
- Check the lint screen located at the back of the machine to ensure that the safety switch activator clip depresses the safety switch.
- Check to see if the proper fuse is installed and that it is serviceable.
- Ensure that the fuse cap is completely seated and secured in its receptacle.

2. The fan is operating although the unit won't produce any ozone...what's wrong?

- Check the ozone plate(s) for serviceability. If they are cracked or broken, the ozone plate(s) will require replacement. Ensure maintenance procedures required for the ozone plate(s) have been performed according to the "Maintenance" section (page 8) of this Owner's Manual. Order new plates from your Dealer.
- Electrical stainless steel contacts are not contacting the screen portion of the Ozone plate(s). Inspect the unit for any loose connections.
- Do not attempt to disassemble the unit, due to the Limited Warranty of the product.

3. How am I able to know if the Frequency-Type Ionizer is working?

- Current models with the FT Ionizer system have a neon light bulb mounted on the base of the FT antenna. When the power switch to the unit is turned ON, the neon light bulb will illuminate, indicating that the FT Ionizer is functioning normally (see page 9, "Indicators of Operation").

4. The Ozone Plate(s) are making a noise, have a burning smell, and/or appear to arc or spark. What is the problem?

- Ozone plate is most likely cracked. Refer to the answers for question # 2, as it would apply to this question also.

5. What are the most typical application problems?

- **Symptom:** A belief that the proper equipment is placed in the environment and the equipment appears unsuccessful.

Problem: Lack of air movement, improper placement of the unit.

- **Symptom:** Strong odors still remain with the environment after placement.

Problem: Lack of ozone, improper placement of the unit.

- **Symptom:** A strong odor of ozone is present within the environment.

Problem: Too much ozone accumulation within the environment, as a result of improper purifier control setting, and / or lack of air movement.

- **Symptom:** Visual haze of smoke and / or particulate remain within the environment.

Problem: Lack of ionization and / or air movement.

6. Unit does not operate -

- Is the unit plugged in?
- Are you sure the outlet is active?
- Is the unit turned on?
- Is the rear lint screen installed properly to depress the safety switch forward?

7. Air flow is restricted or reduced -

- Is the unit properly placed away from objects that may obstruct air flow?
- Are the filter and fan housing clean?

If your unit fails to operate properly after performing trouble-shooting, contact your EcoQuest Dealer for further assistance, contact us at the address located on the front of the manual, or visit www.EcoQuestintl.com for additional technical support.

Eagle 2500™

Electronic Air Purification 110 and 220 volt Systems

WARRANTY INFORMATION

This product is of solid state construction and is warranted by

EcoQuest International, 310 T. Elmer Cox Drive, Greeneville, TN 37743,

to the original purchaser, to be free from defect in materials and workmanship for three-years from date of purchase. (220 volt units are warranted for one year, parts only.) This warranty excludes ozone plates, which are covered for 90 days from the same date of purchase.

See warranty card for specific details.

If you have any questions concerning your Eagle 2500 system, please see your local EcoQuest Dealer.

If your unit is defective, please contact

EcoQuest International, 310 T. Elmer Cox Drive, Greeneville, TN 37743

or visit www.ecoquest.com for technical help.

Did you forget to register your Eagle 2500?

By registering, you'll activate your warranty, and your privacy is guaranteed.

Just fill out your warranty card and drop it in the mail.



EcoQuest International®

310 T. Elmer Cox Drive

Greeneville, TN 37743

423.638.7246

www.ecoquest.com